



“Taking you above the rest”



AVRO Hoist Model SC270/270

6000 lb Twin Cage Man & Material Hoist

AVRO Model SC270/270

6000 lb Twin Cage Man & Material Hoist

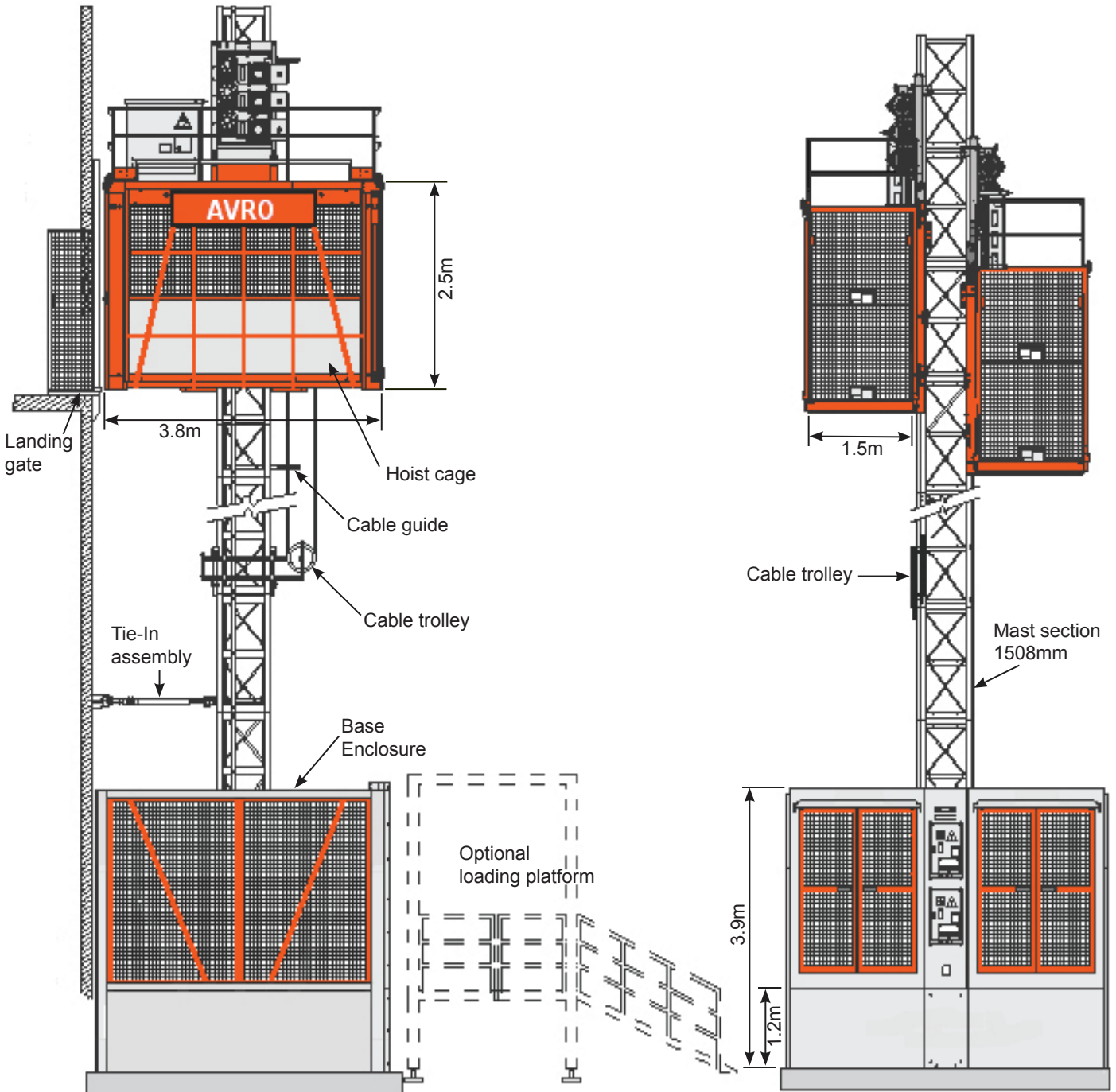

AVRO Model SC270/270

6000 lb Twin Cage Man & Material Hoist

TIE-IN PLAN VIEW

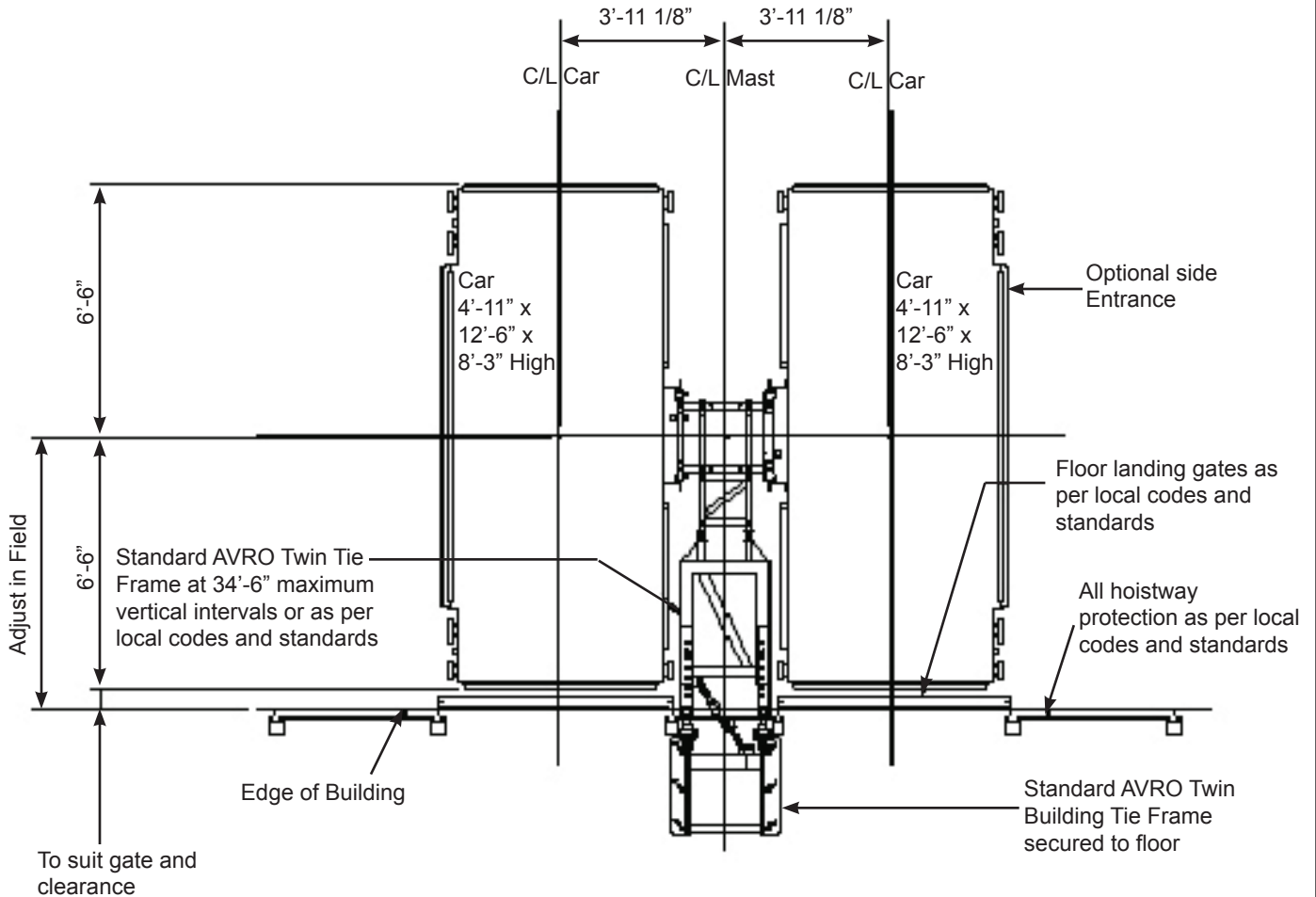

Note: All hoist cages are designed and built in conformance with CAN/CSA-Z185-M87 local safety code. All sizes and dimensions are subject to change at any time without notice and must be verified by a local certified engineer. Any changes or modifications should be consulted with AVRO Hoist Co.

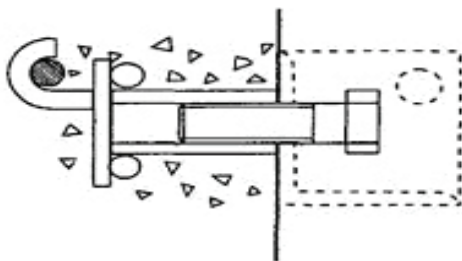

Attached to embedded bracket in structural part of building

MAST TIE CONNECTIONS

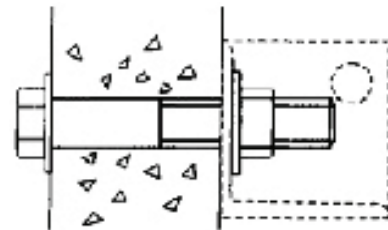

Fixed with through bolts



“Taking you above the rest”

AVRO Model SC270/270

6000 lb Twin Cage Man & Material Hoist

TIE-IN DETAILS

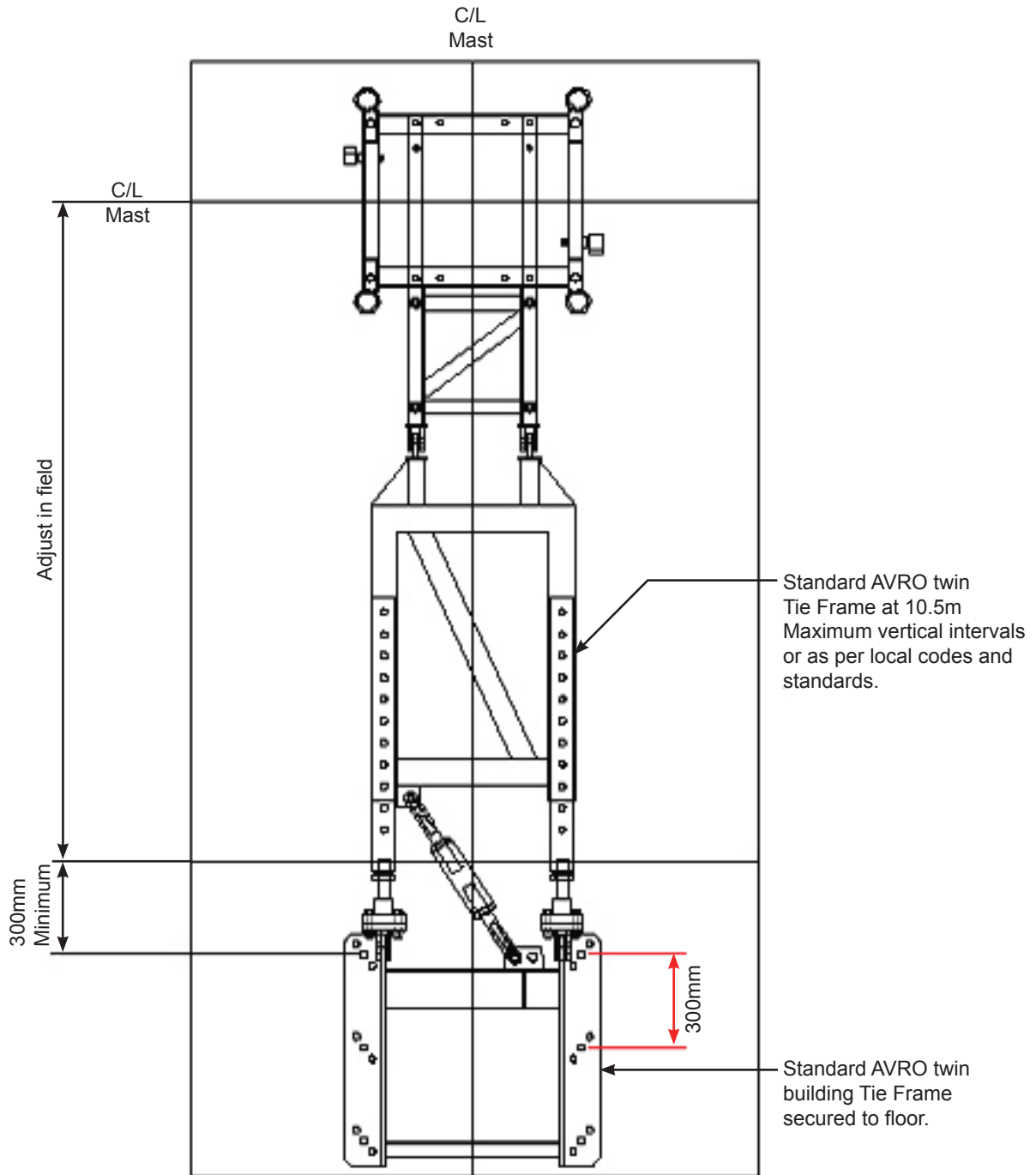

AVRO Model SC270/270

6000 lb Twin Cage Man & Material Hoist

FOUNDATION PLAN

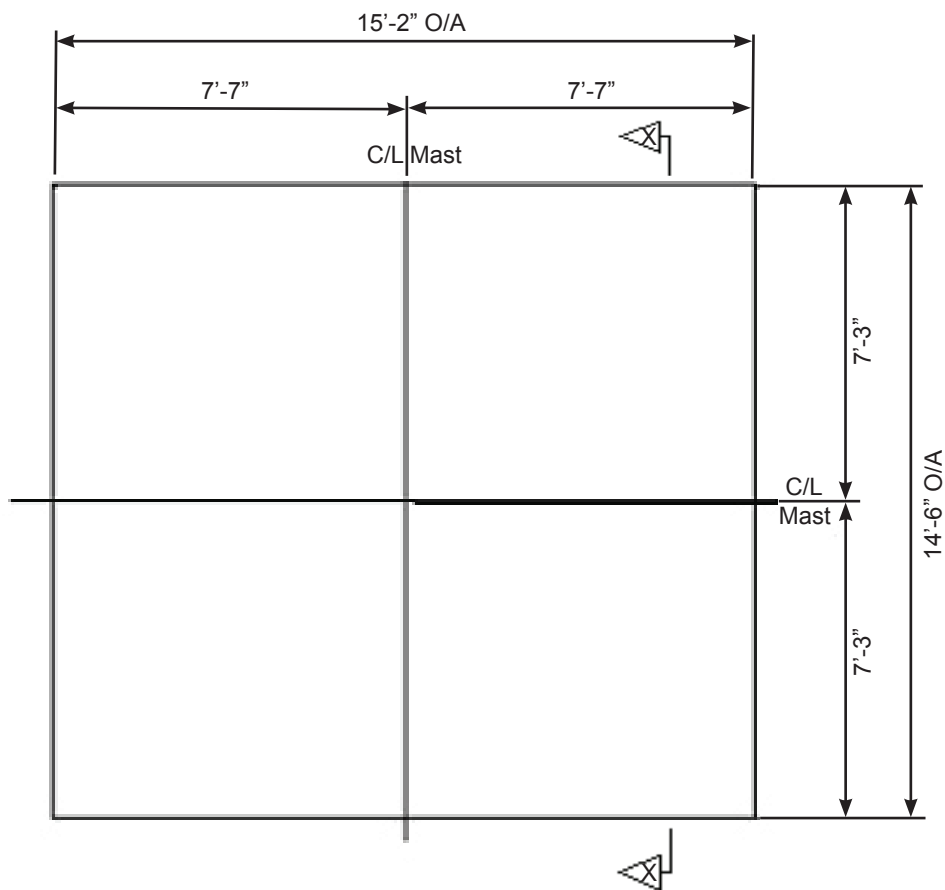

#5 Reinforcing bars
@ 12" C/C Max. Bott.
each way

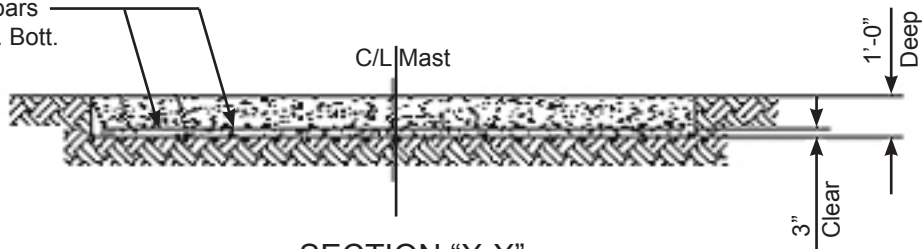

SECTION "X-X"

Note: Minimum soil
bearing pressure required
to be 3,000 PSF

AVRO Model SC270/270

6000 lb Twin Cage Man & Material Hoist

TECHNICAL DATA	SC270/270TD	SC270/270GZ	SCD270/270G
Configuration	Twin cage hoist	Twin cage hoist	Twin cage hoist
Rated load capacity (per car)	6000 lbs	6000 lbs	6000 lbs
Rated speed	150 fpm (46 m/min)	207 fpm (63 m/min)	315 fpm (96 m/min)
Counterweight	No	No	Yes
Maximum travel distance	1476 ft	1476 ft	1476 ft
Lifting device (Jump pole) capacity	550 lbs	550 lbs	550 lbs
Safety device	Type D	Type D	Type D
Worm gear ratio	16:1	12:1	12:1
Brake rating (per car)	155 ft-lb (210 Nm)	155 ft-lb (210 Nm)	155 ft-lb (210 Nm)
CAR DIMENSIONS			
Inside length	3.8m	3.8m	3.8m
Inside width	1.5m	1.5m	1.5m
Inside height	2.5m	2.5m	2.5m
Front/rear gate opening width	1.5m	1.5m	1.5m
Front/rear gate opening height	2m	2m	2m
Optional side gate opening width	2.5m	2.5m	2.5m
Optional side gate opening Height	2m	2m	2m
ELECTRICAL DATA			
Power supply	440-460/3/60	440-460/3/60	440-460/3/60
3-Motor drive machinery:			
Horsepower	(3)x20hp(15kW)	(3)x25hp(18.5kW)	(3)x25hp(18.5kW)
Full load current	92.6 Amp	113.4 Amp	113.4 Amp
Starting current	Varies	Varies	Varies
Variable frequency drive	74hp (55kW)	100hp (75kW)	100hp (75kW)
Brake power supply	195 V.d.c.	195 V.d.c.	195 V.d.c.
WEIGHTS			
Gross weight (per car)	5070 lbs	5500 lbs	5500 lbs
Weight per mast section (4mm-8mm)	275-550 lbs	275-550 lbs	275-550 lbs
Weight of travelling cable system	4 lbs/ft	4 lbs/ft	4 lbs/ft
Weight of Tie-In	10% of total mast weight	10% of total mast weight	10% of total mast weight
Weight of ground enclosure	3260 lbs	3260 lbs	3260 lbs
Weight of Counterweight	N/A	N/A	2 x 4850 lbs

Note: All data is subject to change and should be verified by a local certified engineer.

